

Hauptgruppe Ausgleichgetriebe

0081 0300 000 0

Bild-Nr.	Ersatzteil-Nr.	Benennung	Anzahl	Bemerkung
1	0081 0301 000 0	Ausgleichgehäuse	1	
2	0081 0302 000 0	Ausgleichkegelrad	2	
3	0081 0302 001 0	Ausgleichkegelrad	2	
4	0081 0302 003 0	Buchse	2	
5	0081 0301 003 0	Ausgleichgehäuse	1	
6	0081 0301 005 0	Bolzen	2	
7	M 6 x 10 TGL 0-417	Gewindestift mit Zapfen	2	
8	0081 0300 004 0	Schneckenrad	1	
9	0081 0300 006 0	Zentrierwelle	1	
10	M 10 x 30 TGL 0-933	Sechskantschraube	4	
11	B 10 TGL 7403	Federring	4	
12	10 x 45 TGL 0-1471	Kegelkerbstift	2	

kostenfreier
Scan von
www.et081.de

kostenfreier
Scan von
www.et081.de



Bild-Nr.	Ersatzteil-Nr.	Benennung	Anzahl	Bemerkung
1	0081 0401 000 0	Triebwellenkegelrad	1	kostenfreier Scan von www.et081.de
2	0081 0401 001 0	Triebwellenkegelrad	1	
3	0081 0401 003 0	Buchse	1	
4	0081 0402 000 0	Schaltwelle	1	
5	0081 0403 000 0	Ankerplatte, links	1	
6	0081 0404 000 0	Radnabe	1	
7	0081 0406 000 0	Schalteinrichtung	1	
8	0081 0406 001 0	Schaltbolzen	1	
9	0081 0406 003 0	Schaltgabel	1	
10	5 x 28 TGL 0-1471	Kegelkerbstift	1	
11	0081 0400 007 0	Achsdom, links	1	
12	0081 0400 009 0	Buchse	1	
13	0081 0400 011 0	Triebachse	1	
14	0081 0400 013 0	Differentialsperre	1	
15	0081 0400 019 0	Buchse	1	
16	71201	Radkappe	1	„Robur“ Zittau
17	B 2,8 x 25 x 5,5 TGL 18395	Druckfeder	1	
18	0081 0400 025 0	Dichtung	1	
19	A 12 x 8 x 28 TGL 9500	Paßfeder	1	
20	6007 TGL 2981	Radial-Rillen- kugellager	2	
21	35 TGL 0-471	Sicherungsring	1	
22	62 TGL 0-472	Sicherungsring	3	
23	D 35 x 62 x 10 TGL 16454	Wellendichtring	1	
24	32 TGL 0-472	Sicherungsring	2	
25	D 17 x 32 x 7 TGL 16454	Wellendichtring	1	
26	BM 6 x 16 TGL 5683	Senkschraube	2	
27	M 6 x 16 TGL 0-933	Sechskantschraube	4	
28	B 6 TGL 7403	Federring	4	
29	R 56-07221 IV	Bremsbacke	1	
30	R 56-07222 IV	Bremsbacke	1	
31	0081 0400 047 0	Bremsnocken	1	
32	07.59-70.40:01	Dichtring	1	
33	0081 0407 000 0	Bremshebel	1	
34	0081 0400 050 0	Zugfeder	2	
35	B 8 TGL 7403	Federring	1	
36	M 8 TGL 0-933	Sechskantmutter	1	
37	A 10 x 8 x 28 TGL 9500	Paßfeder	1	
38	26 TGL 0-432	Sicherungsbl. mit Außennase	1	
39	M 24 x 1,5 TGL 0-934	Sechskantmutter	1	

kostenfreier
Scan von
www.et081.de

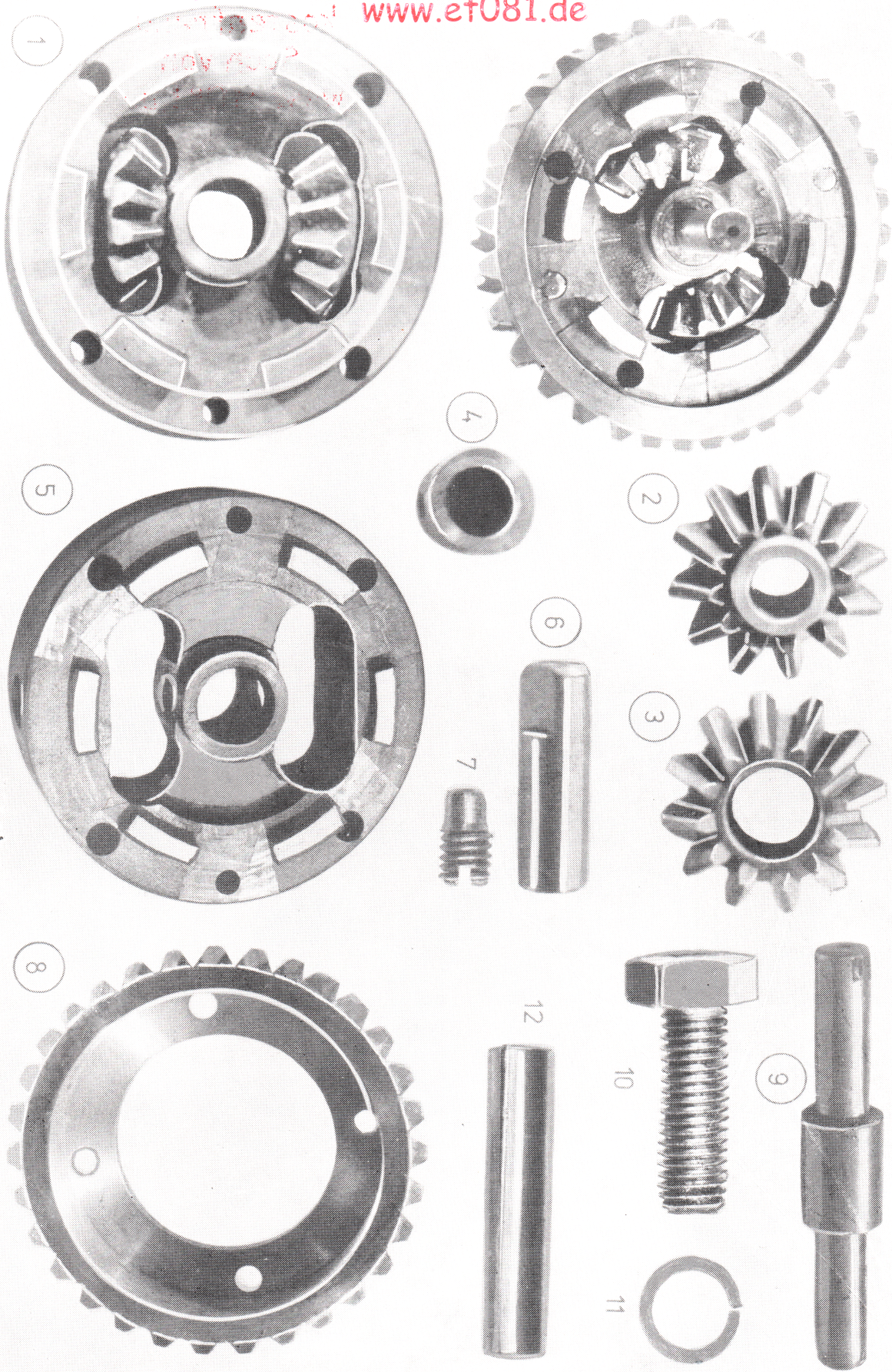

Bild-Nr.	Ersatzteil-Nr.	Benennung	Anzahl	Beimerkung
1	0081 0601 000 1	Schaltwelle	1	kostenlos Scan von www.et081.de
2	0081 0601 001 1	Schaltwelle	1	
3	0081 0601 003 1	Schaltstück	1	
4	B 16 TGL 7403	Federring	1	
5	M 16 x 1,5 TGL 0-936	Fl. Sechskantmutter	1	
6	0081 0600 003 0	Schaltgabel	2	
7	B 10 TGL 7403	Federring	2	
8	BM 10 TGL 0-439	Fl. Sechskantmutter	2	
9	0081 0602 000 1	Schaltwelle	1	
10	0081 0602 001 1	Schaltwelle	1	
11	0081 0602 003 0	Schaltgabel	1	
12	0081 0602 005 0	Distanzbuchse	1	
13	0081 0602 007 1	Schaltstück	1	
14	B 16 TGL 7403	Federring	1	
15	M 16 x 1,5 TGL 0-936	Fl. Sechskantmutter	1	
16	0081 0603 000 1	Schaltwelle	1	
17	0081 0603 001 1	Schaltwelle	1	
18	0081 0602 003 0	Schaltgabel	1	
19	0081 0603 005 0	Distanzbuchse	1	
20	0081 0602 007 1	Schaltstück	1	
21	B 16 TGL 7403	Federring	1	
22	M 16 x 1,5 TGL 0-936	Fl. Sechskantmutter	1	
23	0081 0604 000 1	Schaltwelle	1	
24	0081 0604 001 1	Schaltwelle	1	
25	0081 0604 003	Schaltstück	1	
26	B 16 TGL 7403	Federring	1	
27	M 16 x 1,5 TGL 0-936	Fl. Sechskantmutter	1	
28	0081 0600 028 0	Getriebedeckel	1	
29	0081 0600 030 1	Lagerleiste, vorn	1	
30	0081 0600 032 0	Lagerleiste, hinten	1	
31	B 8 TGL 7403	Federring	4	
32	M 8 x 25 TGL 0-933	Sechskantschraube	4	
33	0081 0600 037 0	Lagerplatte	1	
34	0081 0600 039 0	Kugelbolzen	3	
35	0081 0600 040 0	Kugelschale	6	
36	0081 0600 041 0	Lagerplatte	1	
37	B 10 TGL 7403	Federring	4	
38	M 10 x 30 TGL 0-933	Sechskantschraube	4	
39	Form 04 016	Gummistaubkappe	3	
40	BM 10 TGL 0-439	Fl. Sechskantmutter	3	
41	0081 0600 050 0	Bügel	3	
42	∅ 6 TGL 15515	Kugel	7	
43	C 0,8 x 5,5 x 17,5 TGL 18 395	Druckfeder	4	
44	M 8 x 20 TGL 0-553	Gewindestift	4	
45	M 8 TGL 0-934	Sechskantmutter	4	
46	DA 52 x 105-4 KGTS 11400	Erzeugniskennschild	1	
47	3 x 6 TGL 0-1476	Halbrundkerbnagel	4	
48	BM 8 x 20 TGL 0-939	Stiftschraube	2	
49	M 14 x 1,5 TGL 0-7604	Verschlußschraube	1	
50	C 14 x 20 TGL 0-7603	Dichtring	1	

kostenfreier
Scan von
www.et081.de

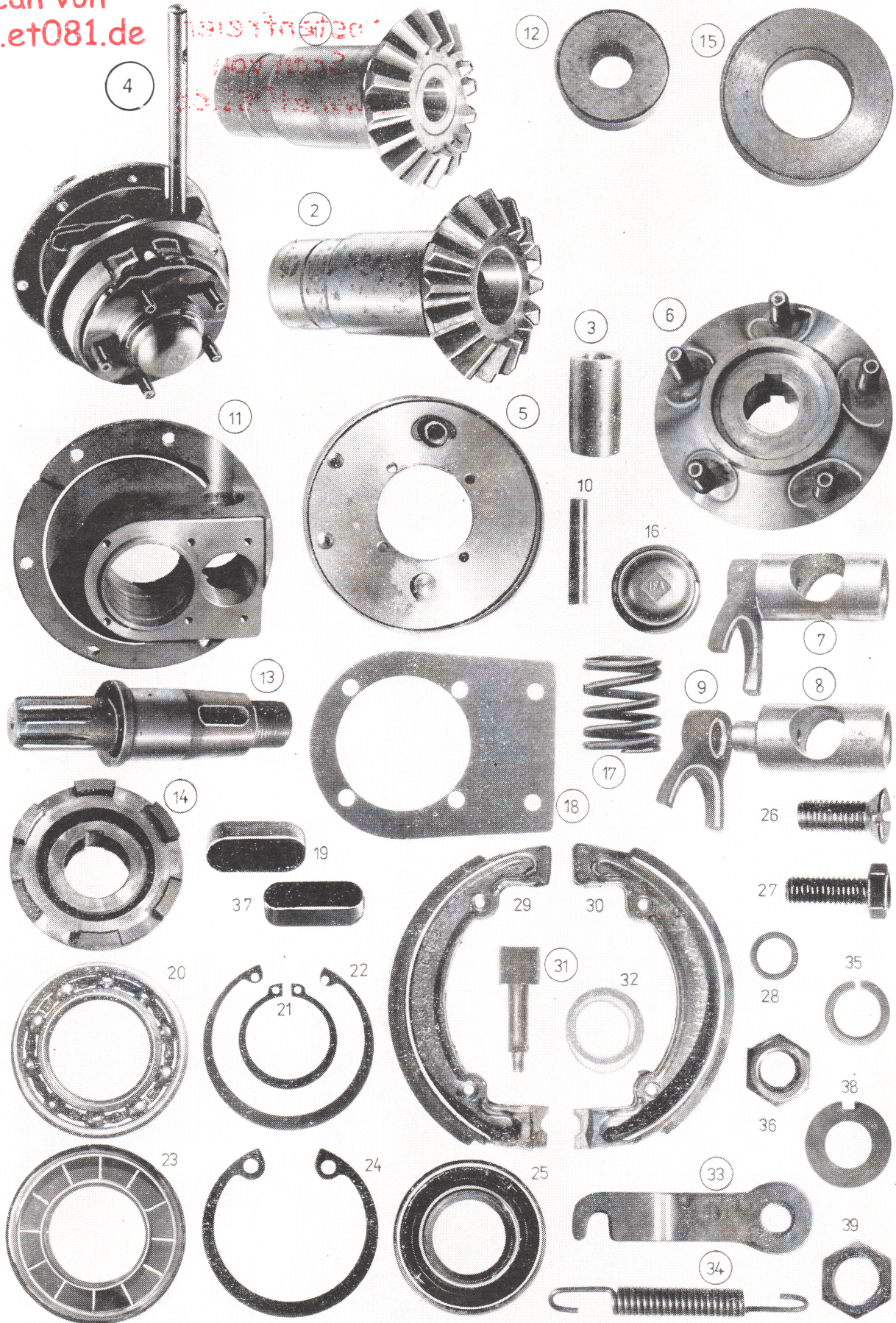
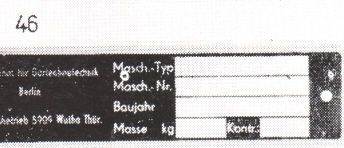
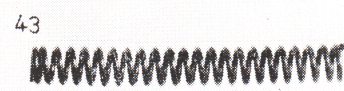
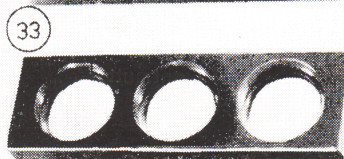
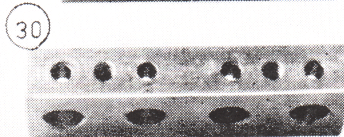
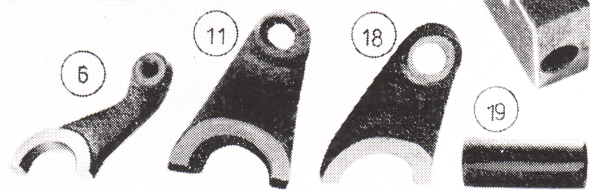
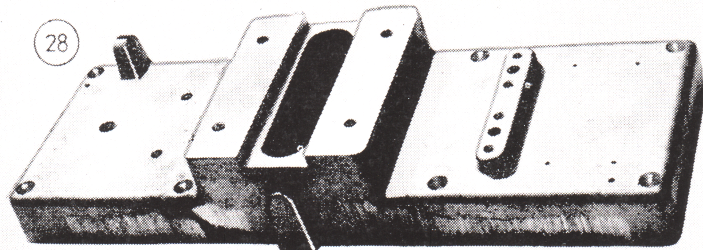
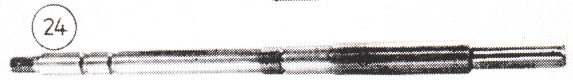
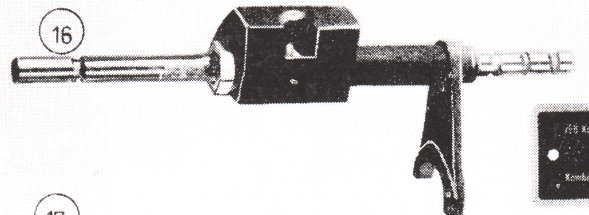
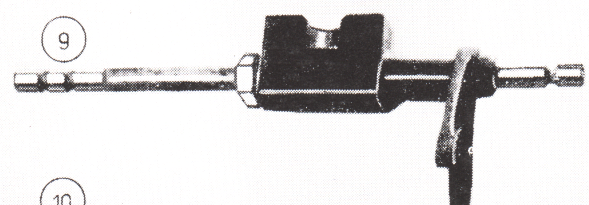
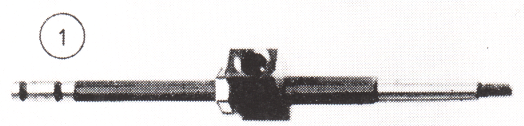
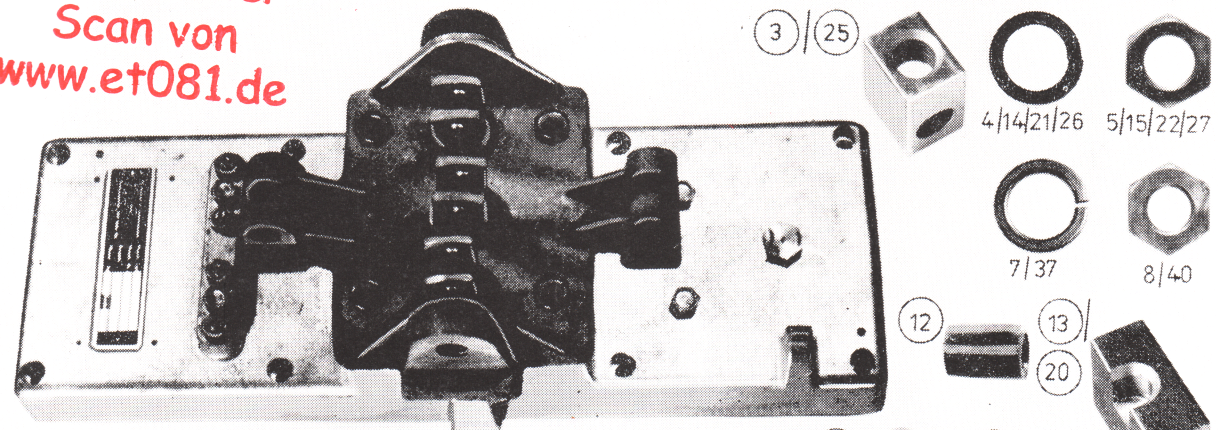

159 Kombiact für Dürrscheibechnik
Berlin
Kombiactbetriebe 5009 Walke Thür.

Masch.-Typ	
Masch.-Nr.	
Baujahr	
Masse kg	Kontroll

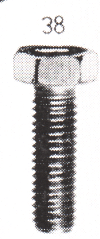
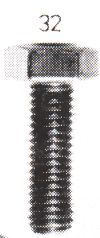
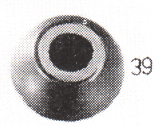
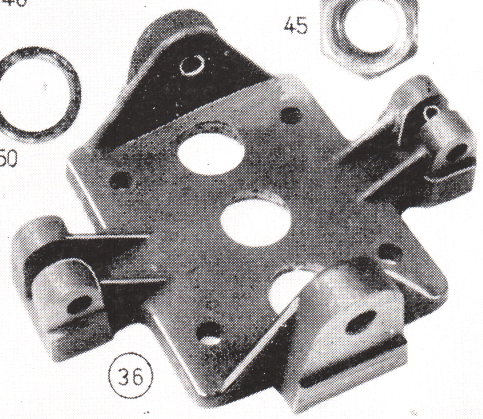
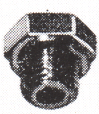

Hauptgruppe Lenkung

0081 0700 000 1

Bild-Nr.	Ersatzteil-Nr.	Benennung	Anzahl	Bemerkung
1	0081 0701 000 1	Lenkrohr	1	
2	0081 0701 013 0	Schild	1	Schaltschema
3	0081 0701 015 0	Schild	1	Schaltschema
4	3 x 6 TGL 0-1476	Halbrundkerbnagel	4	
5	0081 0700 009 0	Klemmstück	1	
6	AM 10 x 50 TGL 16299	Kegelgriffschraube	1	
7	0081 0700 014 0	Gewindebolzen	1	
8	0081 0702 000 1	Führungsraute	1	
9	0081 0700 017 1	Feststellbolzen	1	
10	A 1,4 x 15 x 17,5 TGL 18395	Druckfeder	1	
11	4 m 6 x 28 TGL 0-7	Zylinderstift	1	
12	B 40 TGL 2950	Kugelgriff	1	
13	13 TGL 0-125	Scheibe	2	
14	M 12 TGL 0-934	Sechskantmutter	2	
15	0081 0703 000 1	Lenkholmanschluß, links	1	
16	17 TGL 0-125	Scheibe	1	
17	0081 0704 000 1	Lenkholmanschluß, rechts	1	
18	B 16 TGL 0-99	Kegelgriff	1	
19	0081 0706 000 1	Lenkholm, links	1	
20	0081 0707 000 1	Lenkholm, rechts	1	
21	B 30 x 30	Gummifeder	8	
22	B 8 TGL 7403	Federring	16	
23	M 8 x 10 TGL 0-933	Sechskantschraube	16	
24	Nr. 371 TGL 39-441 Bl. 2	Kupplungshebel, komplett	1	
25	Nr. 474 A DIN 71902	Luftregulierhebel, komplett	1	
26	AM 6 x 45 TGL 5687	Linsensschraube	1	
27	B 6 TGL 7403	Federring	1	
28	M 6 TGL 0-934	Sechskantmutter	1	
29	0081 0705 000 0	Hebellager	1	
30	M 6 x 16 TGL 0-933	Sechskantschraube	1	
31	B 6 TGL 7403	Federring	1	
32	M 6 TGL 0-934	Sechskantmutter	1	
33	Nr. 350-3 TGL 39-441 Bl. 2	Hebel	1	
34	Nr. 350-2 TGL 39-441 Bl. 3	Hebel	1	
35	M 6 x 40 TGL 39-285/6	Stellschraube	2	
36	M 6 TGL 39-285/6	Rändelmutter	2	
37	CM 6 x 18 TGL 0-85	Linsenschraube	2	
38	M 6 TGL 0-934	Sechskantmutter	2	
39	∅ 20	Gummi-Handgriff	2	

kostenfreier
Scan von
www.et081.de

kostenfreier
Scan von
www.et081.de

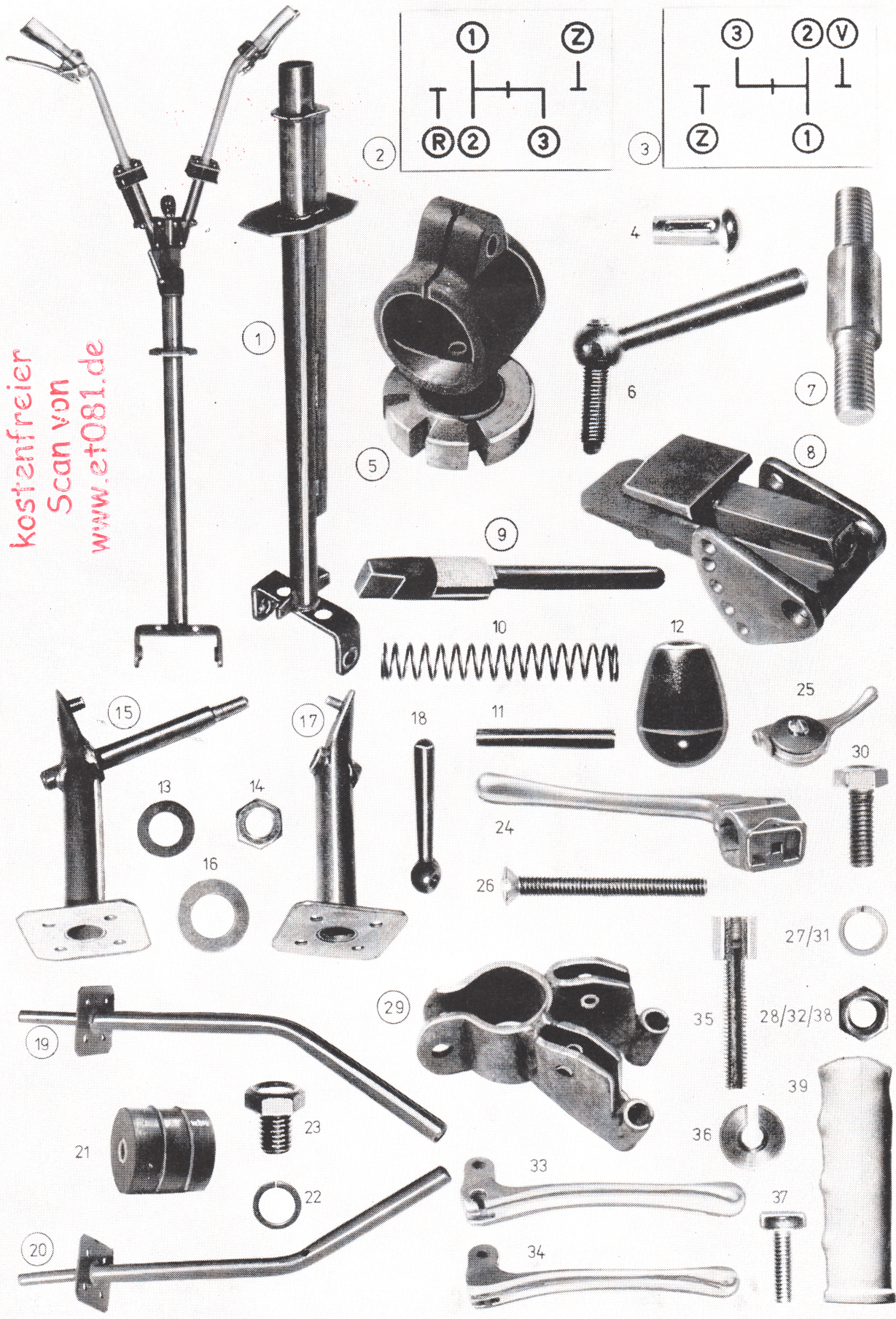

Hauptgruppe Rad 0081 0800 000 0

Bild-Nr.	Ersatzteil-Nr.	Benennung	Anzahl	Bemerkung
1	0081 0801 000 0	Scheibenrad	2	kostenfreier Scan von www.et081.de
2	0081 0801 001 0	Scheibenradhälfte	2	
3	0081 0801 003 0	Scheibenradhälfte	2	
4	BM 8 x 20			
	TGL 5683	Senkschraube	10	
5	B 8 TGL 7403	Federring	10	
6	M 8 TGL 0-934	Sechskantmutter	10	
7	5.00-8			
	TGL 6506 Bl. 1	Reifen	2	
8	5.00-8 TGL 20175	Luftschlauch	2	
9	A 8 TGL 104-6	Wulstband	2	

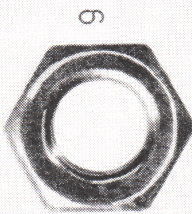
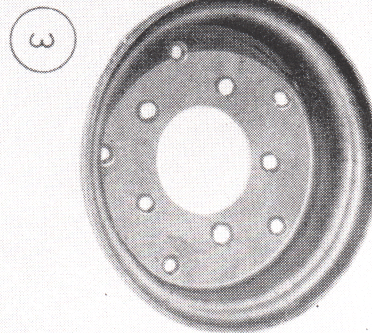
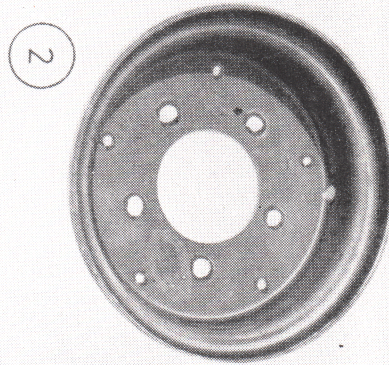
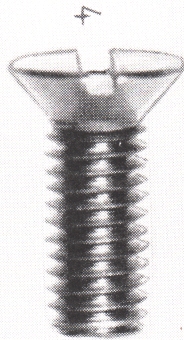
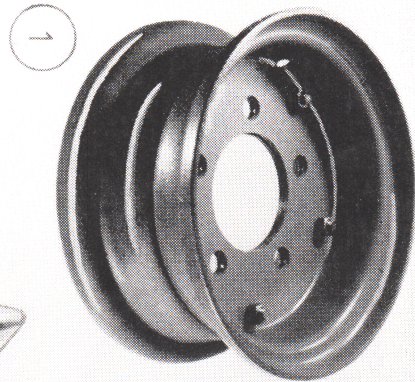
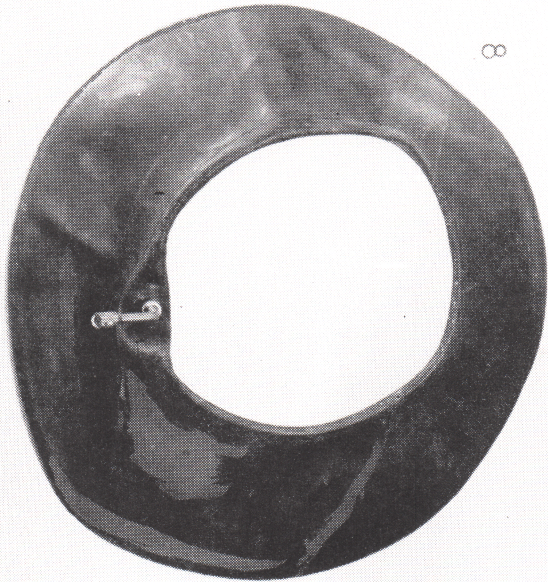
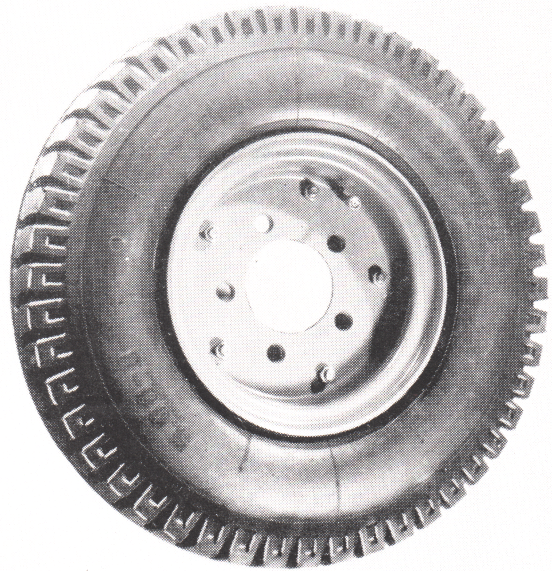

kostenlos
Scan von
www.et081.de

